

300kVA Transformer

Portable Power Distribution



APPLICATION RANGE

Trystar Step Down Transformer
300kVA 480V:208Y/120V

STANDARD FEATURES

- NEMA 3R all aluminum construction
- Mounted in heavy-duty cage w/castors, forklift pockets, and lifting eyes
- Custom powder coat
- Custom UV-printed graphics
- Made in USA

CONFIGURATION

- Primary Side
 - 4-Wire Camlok Input (BN, OR, YW, GN)
 - 400A 3P Primary Side Transformer Circuit Breaker
- Output
 - 5-Wire Camlok Output (BK, RD, BE, WT, GN)
 - 800A 3P Secondary Side Transformer Circuit Breaker

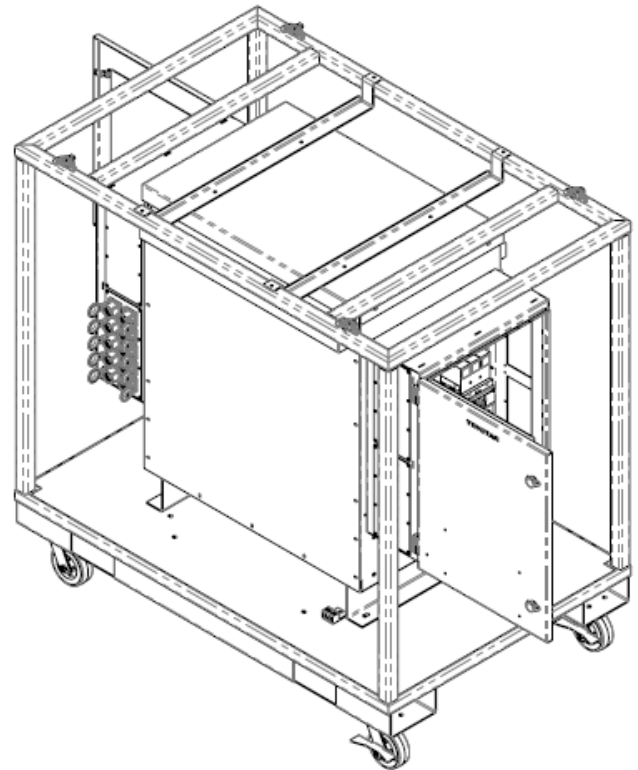

LISTINGS

- UL1640 Listed
- C(ETL) Listed
- UL 50 Listed
- NEMA 3R

*Images are representative, specific final design details may vary

300kVA Transformer

DIMENSIONS AND WEIGHTS



APPROXIMATE WEIGHT: 2500 LBS.

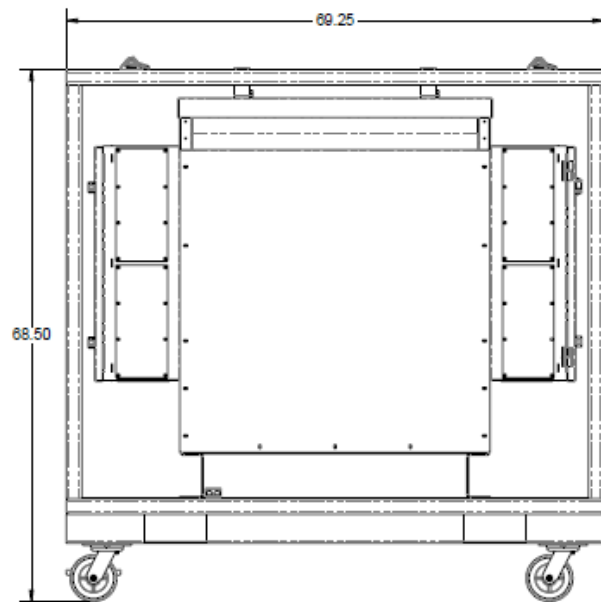
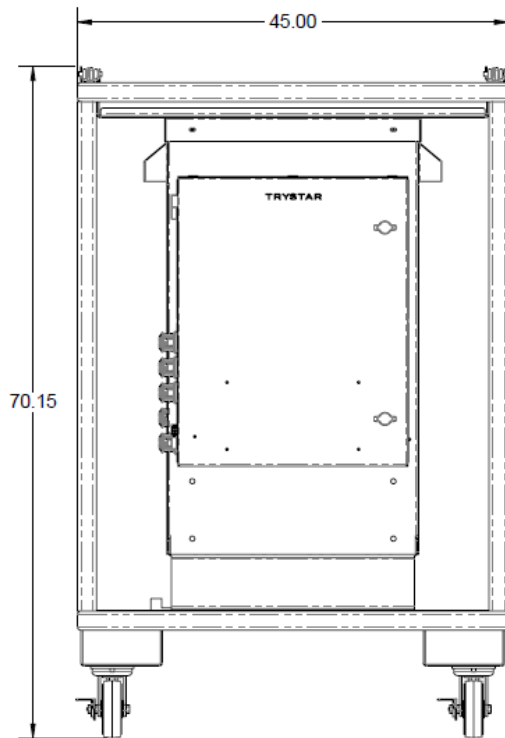

*Dimensions are representative, specific final design details may vary